

**gizir**<sup>®</sup>  
WOOD PRODUCTS

**3D  
PANEL**

**HW**  
**HIJAZI WOOD**  
OMAN



# What is 3D PANEL?

3D Panel is our newest innovative solution for premium interior furniture. MDF is first laminated with a foam layer. Then, foam laminated MDF is covered with the desired foil. As the last step, pressure is applied on the panel to give it the desired 3D design.

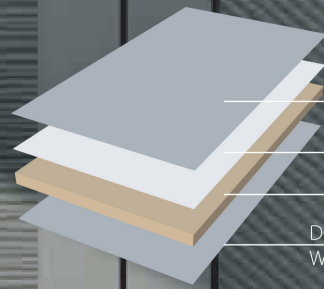

PVC OR PP  
DECORATIVE FOIL  
FOAM  
MDF

DOUBLE FACED/  
WHITE MELAMINE  
BACKSIDE

**DOUBLE FACED/  
WHITE MELAMINE  
BACKSIDE**

## PANEL DIMENSIONS

Width	1220mm
Length	2800mm
Thickness	18/10mm

\*thickness options available







# COLOR & DECORS

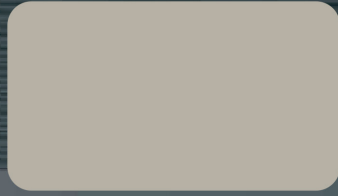

S034

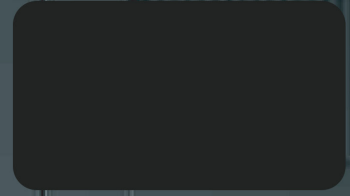

S040

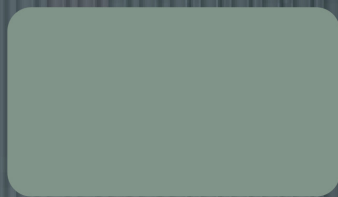

S063

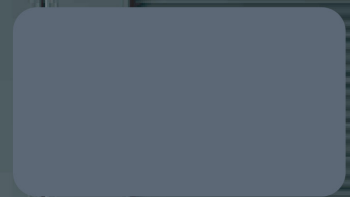

S064



7094

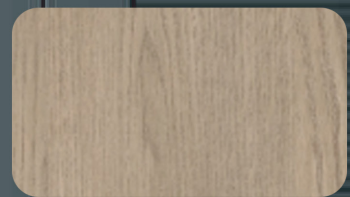

7093



# 3

## *Design Options available in SUPERMATT*



3D01

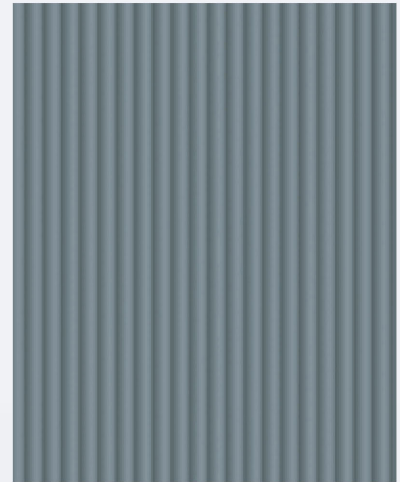
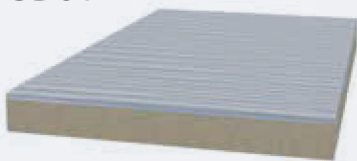

3D03

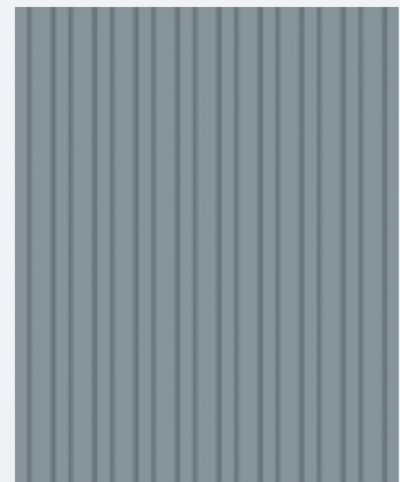

3D06

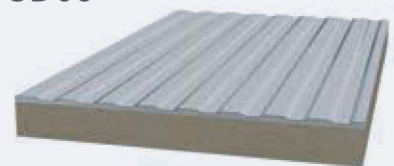

\*Custom designs can be made upon request.

\*Aluminium J handles of same color & foils are available.

# How to FINISH THE SIDES?

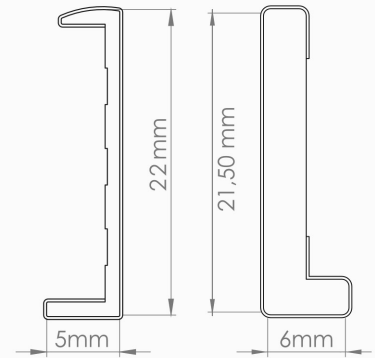

## SIDE PROFILES (mm)

Length	2800
Width	22 / 21,5

Instead of regular edgebanding, aluminium or MDF edge profiles of same color & foil are used to achieve a cleaner & more

elegant look. Accessories can be applied by using PU transparent mounting adhesive in the applications of both J handle and aluminium edge profile

- \* Custom designs can be made upon request.  
Aluminium J handles of same color & foils are available.

If aluminium edge profiles are going to be used for all 4 sides they should be cut in a 45° angle.

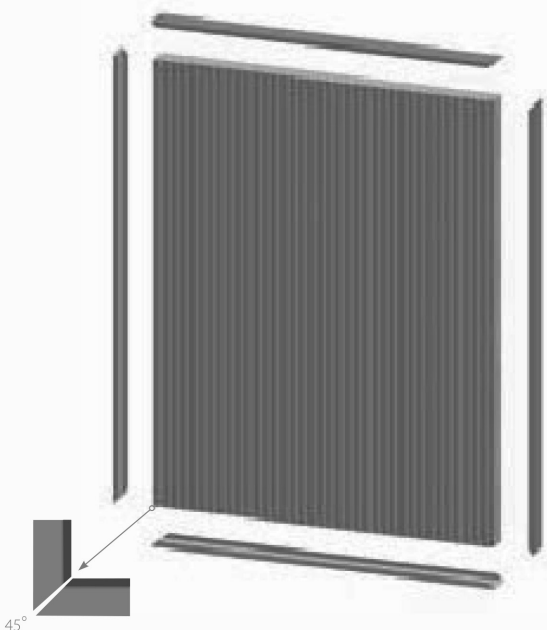

Use PU transparent mounting adhesive in the applications of aluminium edge profiles.



## TECHNICAL INFORMATIONS

No	FEATURE	VALUE	RESULT (Super matt)	STANDART
1	Gloss level (60° angle)	-	5 GU	TS EN 14323
2	Scratch resistance	H	3H	TS 7385
3	Assessment of surface resistance to wet heat (85°C)	5	5 (No change)	TS EN 12721+A1:2014:02
4	Assessment of surface resistance to dry heat (70°C)	5	5 (No change)	TS EN 12722+A1:2014:02
5	Surface abrasion resistance	5	250 rev. (Class 4)	TS EN 14323 : 2021-12 6.9
6	Behavior towards impact loading by falling steel ball	5	2 (There is change)	TS EN 14323:2021-12 6.13
7	Test of water steam resistance	5	2 (There is change)	TS EN 14323:2021-21,Art. 6.10
8	Resistance to staining	5	5 (No change)	TS EN 14323 6.6
9	Assessment of surface resistance to chemical cold liquids (Acetic acid, acetone, ammonia solution, citric acid, cleaning agent, etc.)	5	5 (No change)	TS EN 12720:2009+A1:2014-02
10	Colorfastness to light	5	5. Grade	TS EN 15187
11	Thickness tolerance	-	± 0,30 mm	TS EN 324-1
12	Bow tolerance	-	3,5 mm / m	Gizir
13	Width and Length tolerance	-	± 5 mm / m	TS EN 324-1

- These values are weighted average of the test results.

- The test results of the 6th and 7th tests became the 2nd level out of the 5th level according to the product standard determined by TSE.



**Sultanate of Oman - Muscat**  
**Al Seeb al Maabelah**

+968 951 369 29 +968 951 369 65  
info@hijaziwoodoman.com  
www.hijaziwoodoman.com